

Article number: 20055555

Description: E+G Quick-fit coupling (radial displacement)
GN 240-M16x1,5-B

Measures

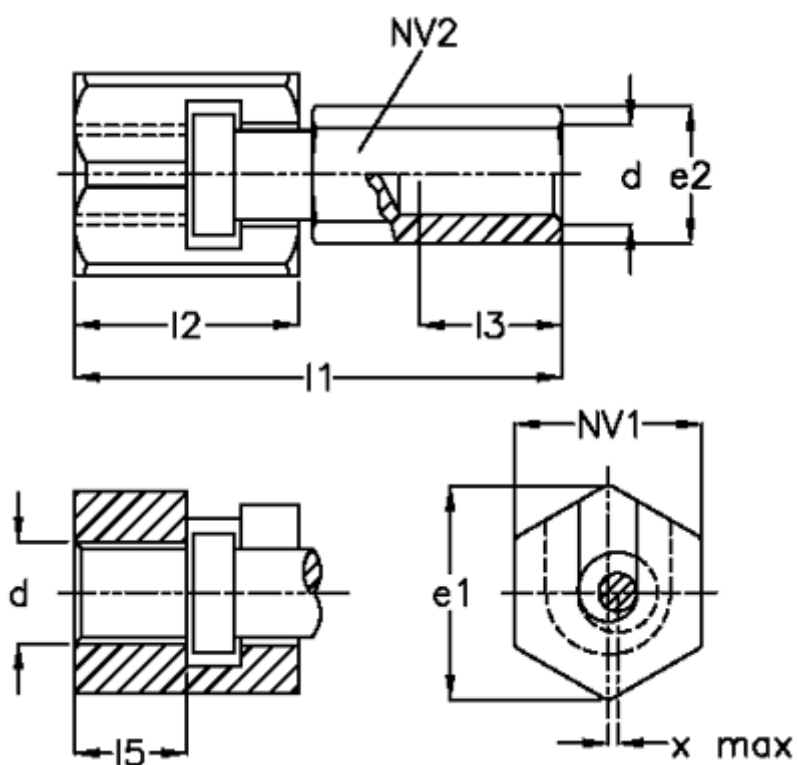

d	= M 16x1,5	Max push-pull strength N = 18000
e1	= 39.0	NV 1 = 36
e2	= 27.0	NV 2 = 24
l1	= 83.5	
l2	= 42.0	
l3	= 25.0	
l5 +1	= 23.0	
Max displacement	= 1.0	